

### TOP VIEW

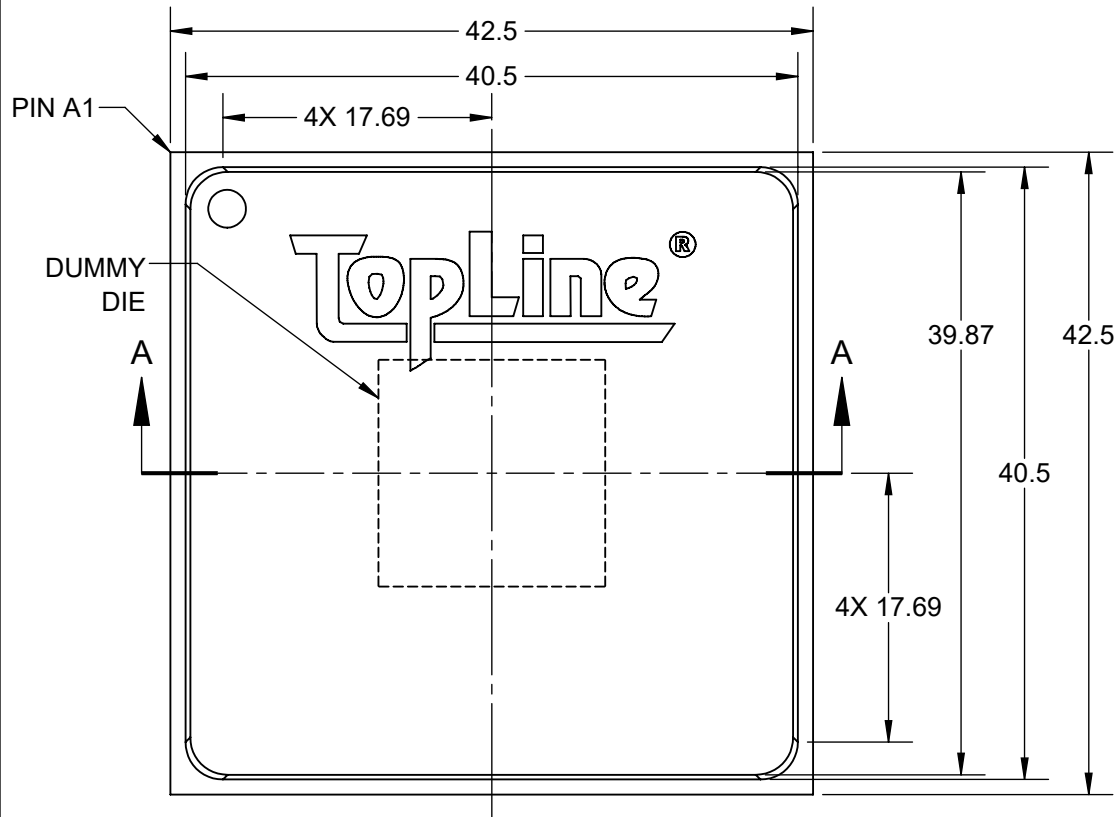

### BALL VIEW

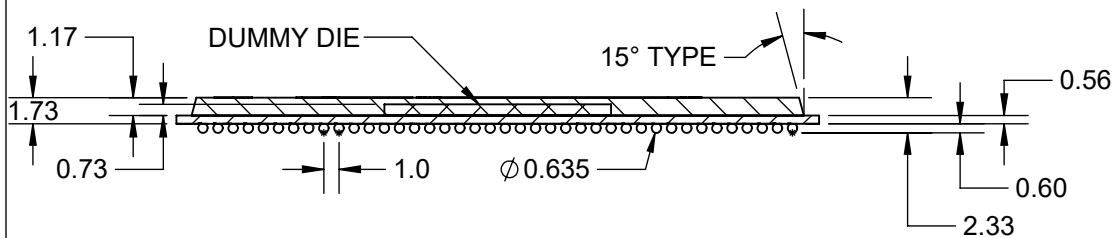
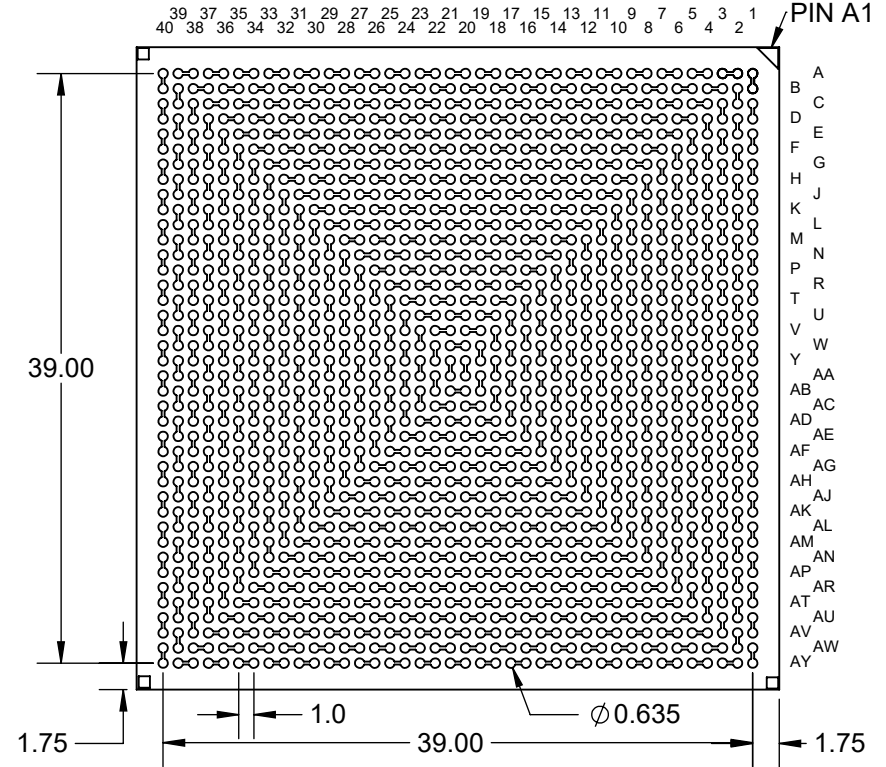

Notes: (Unless Otherwise Specified)

1. DIMENSIONS ARE IN mm.
2. SOLDER BALL ALLOY: TIN LEAD: Sn63/Pb37.  
RoHS LEAD FREE: SAC305 (Sn96.5/Ag3.0/Cu0.5).  
ADDITIONAL BALL ALLOY AVAILABLE.
3. BALL DIAMETER (BEFORE REFLOW): 0.635mm.
4. SOLDERMASK DEFINED PAD OPENING: 0.50mm.
5. PAD Cu DIAMETER : 0.635mm.
6. SUBSTRATE MATERIAL: BT.

PART NUMBER	BALL ALLOY	Pb-Free	RoHS	Si DIE
BGA1600T1.0C-DC409D	Sn96.5/Ag3.0/Cu0.5	YES	YES	YES
BGA1600T1.0-DC409D	Sn63/Pb37	NO	NO	YES

APPROVALS	DATE	<b>TopLine®</b>			
DRAWN T. Au	2/2/2020				
ENG M. Hart	2/2/2020	TITLE (P)BGA1600T1.0-DC409 DAISY CHAIN DUMMY			
MFG		SCALE	SIZE	DRAWING NO.	REV
QA		2:1	A	514094	A
CUST		DO NOT SCALE DRAWING			SHEET 1 OF 5
REVISED					

### BALL VIEW

39 37 35 33 31 29 27 25 23 21 19 17 15 13 11 9 7 5 3 1  
40 38 36 34 32 30 28 26 24 22 20 18 16 14 12 10 8 6 4 2

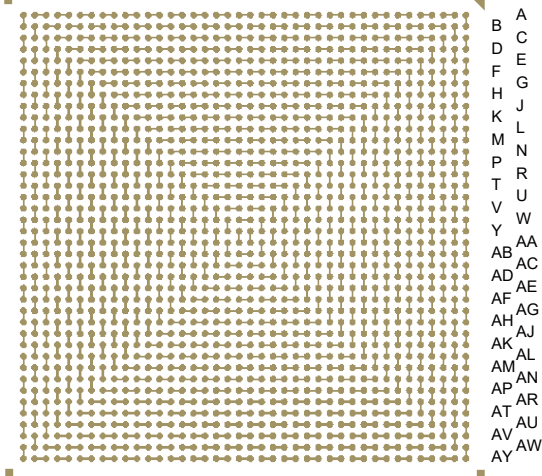

### TOP VIEW (X-RAY)

1 3 5 7 9 11 13 15 17 19 21 23 25 27 29 31 33 35 37 39  
2 4 6 8 10 12 14 16 18 20 22 24 26 28 30 32 34 36 38 40

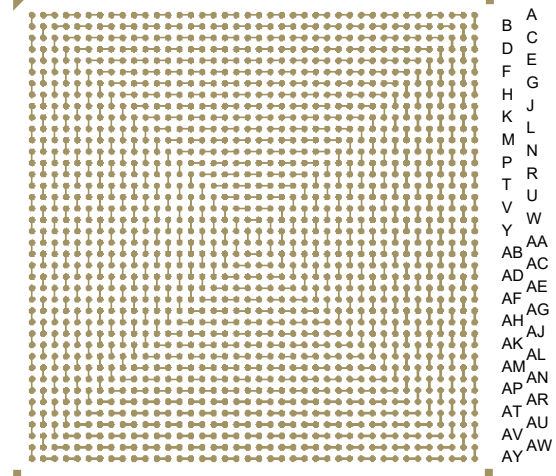

### TEST VEHICLE BOARD

1 3 5 7 9 11 13 15 17 19 21 23 25 27 29 31 33 35 37 39  
2 4 6 8 10 12 14 16 18 20 22 24 26 28 30 32 34 36 38 40

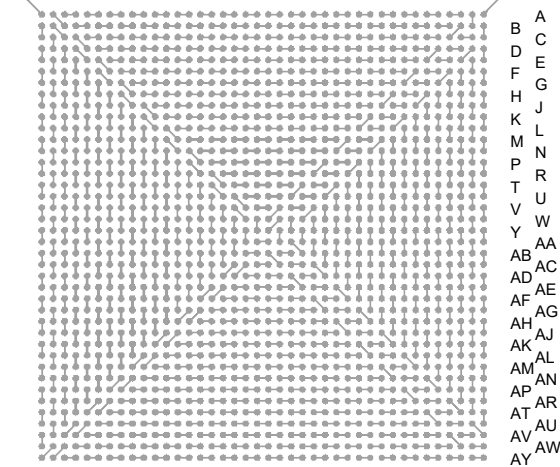

### AFTER MOUNTING TO TEST BOARD

1 3 5 7 9 11 13 15 17 19 21 23 25 27 29 31 33 35 37 39  
2 4 6 8 10 12 14 16 18 20 22 24 26 28 30 32 34 36 38 40

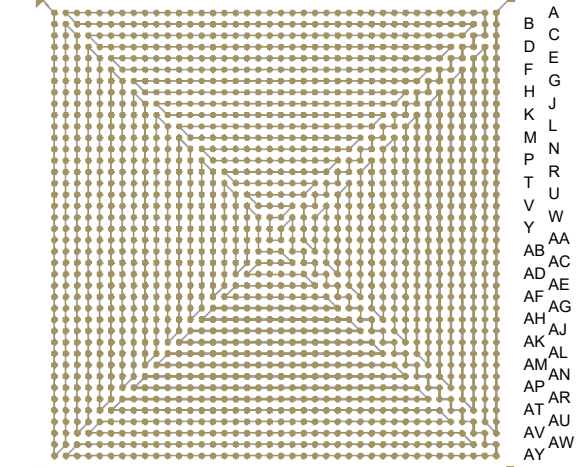

#### Notes:

1. PCB BOARD DIMENSIONS ARE PRESENTED ONLY AS A GUIDELINE.
2. DESIGNER SHOULD USE THEIR OWN EXPERIENCE WHEN DESIGNING PCB.
3. PCB Cu BALL PAD DIAMETER: 0.635mm (25mil).
4. DAISY CHAIN TRACING LINE WIDTH 0.20mm (8mil).
5. SMD (SOLDER MASK DEFINED) PAD OPENING 0.5mm (19.7mil).

**TopLine®**

TITLE (P)BGA1600T1.0-DC409  
DAISY CHAIN DUMMY

SCALE	SIZE	DRAWING NO.	REV
3:2	A	514094	A

DO NOT SCALE DRAWING

SHEET 2 OF 5

# BALL VIEW

40 39 38 37 36 35 34 33 32 31 30 29 28 27 26 25 24 23 22 21 20 19 18 17 16 15 14 13 12 11 10 9 8 7 6 5 4 3 2 1

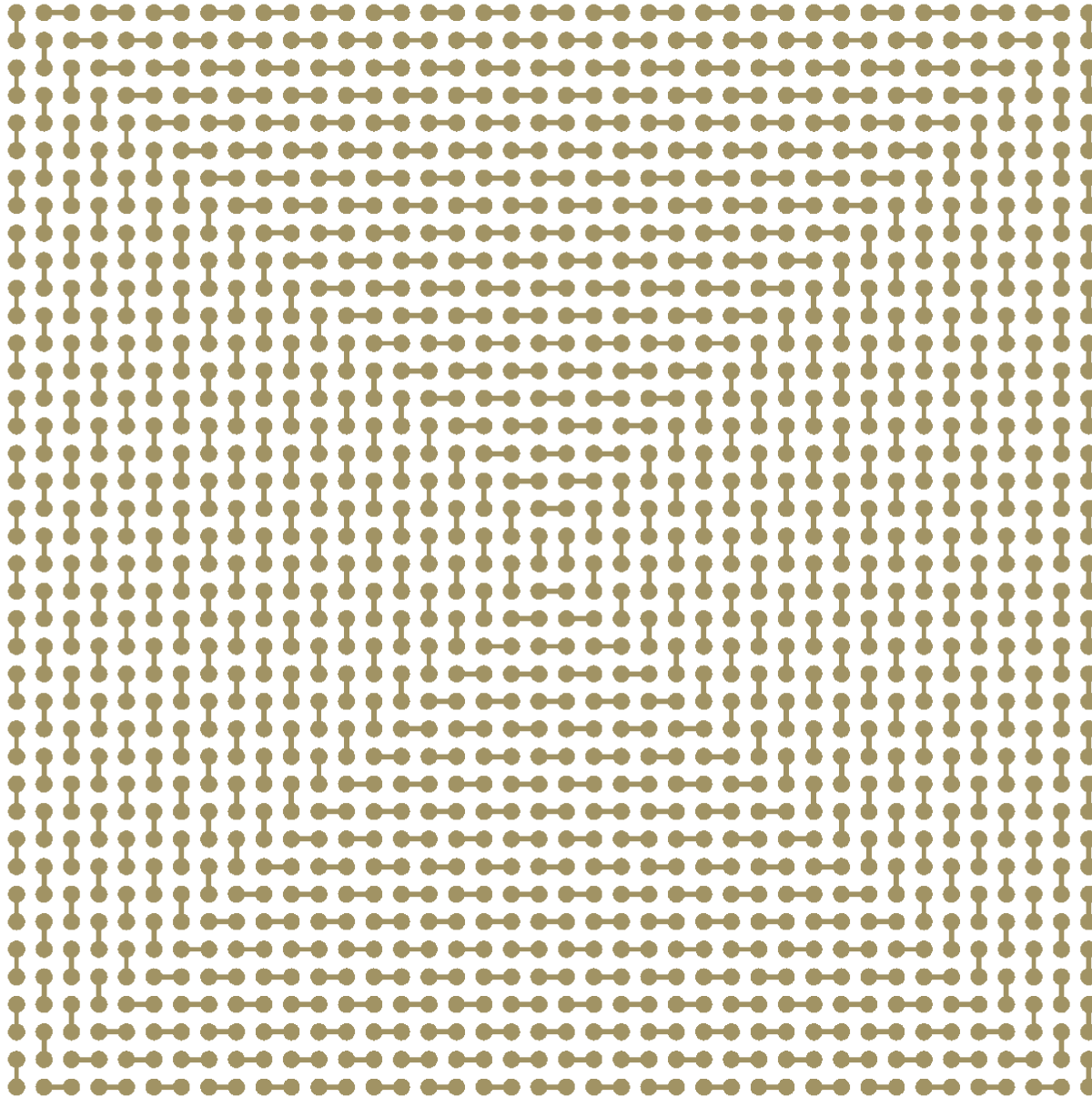

A  
B  
C  
D  
E  
F  
G  
H  
J  
K  
L  
M  
N  
P  
R  
T  
U  
V  
W  
Y  
AA  
AB  
AC  
AD  
AE  
AF  
AG  
AH  
AJ  
AK  
AL  
AM  
AN  
AP  
AR  
AT  
AU  
AV  
AW  
AY

<b>TopLine®</b>			
TITLE		(P)BGA1600T1.0-DC409 DAISY CHAIN DUMMY	
SCALE	SIZE	DRAWING NO.	REV
4:1	A	514094	A
DO NOT SCALE DRAWING			SHEET 3 OF 5

# TOP VIEW (X-RAY)

1 2 3 4 5 6 7 8 9 10 11 12 13 14 15 16 17 18 19 20 21 22 23 24 25 26 27 28 29 30 31 32 33 34 35 36 37 38 39 40

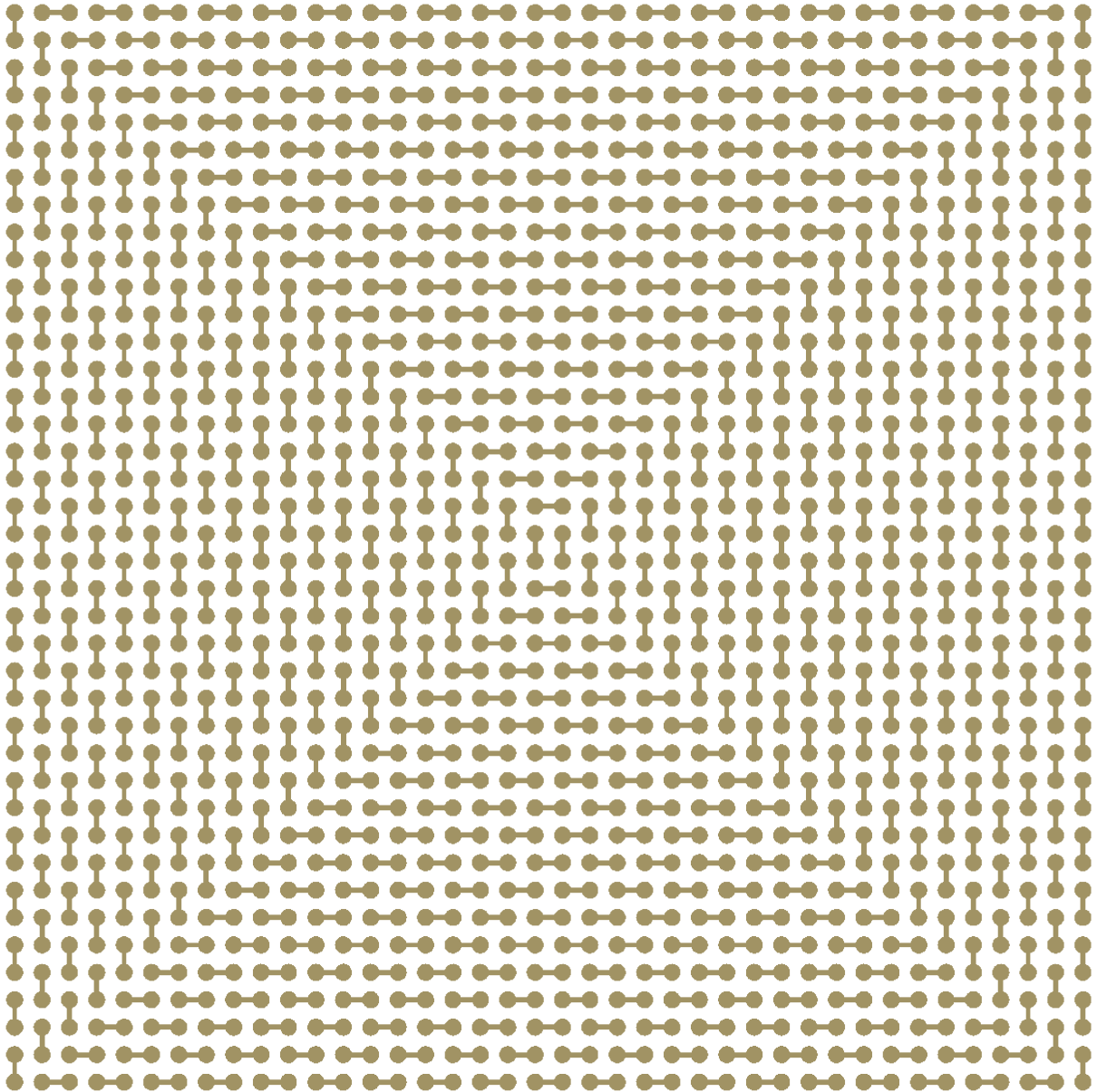

A  
B  
C  
D  
E  
F  
G  
H  
J  
K  
L  
M  
N  
P  
R  
T  
U  
V  
W  
Y  
AA  
AB  
AC  
AD  
AE  
AF  
AG  
AH  
AJ  
AK  
AL  
AM  
AN  
AP  
AR  
AT  
AU  
AV  
AW  
AY

<b>TopLine®</b>			
TITLE		(P)BGA1600T1.0-DC409 DAISY CHAIN DUMMY	
SCALE	SIZE	DRAWING NO.	REV
4:1	A	514094	A
DO NOT SCALE DRAWING			SHEET 4 OF 5

# MODELS

TOP

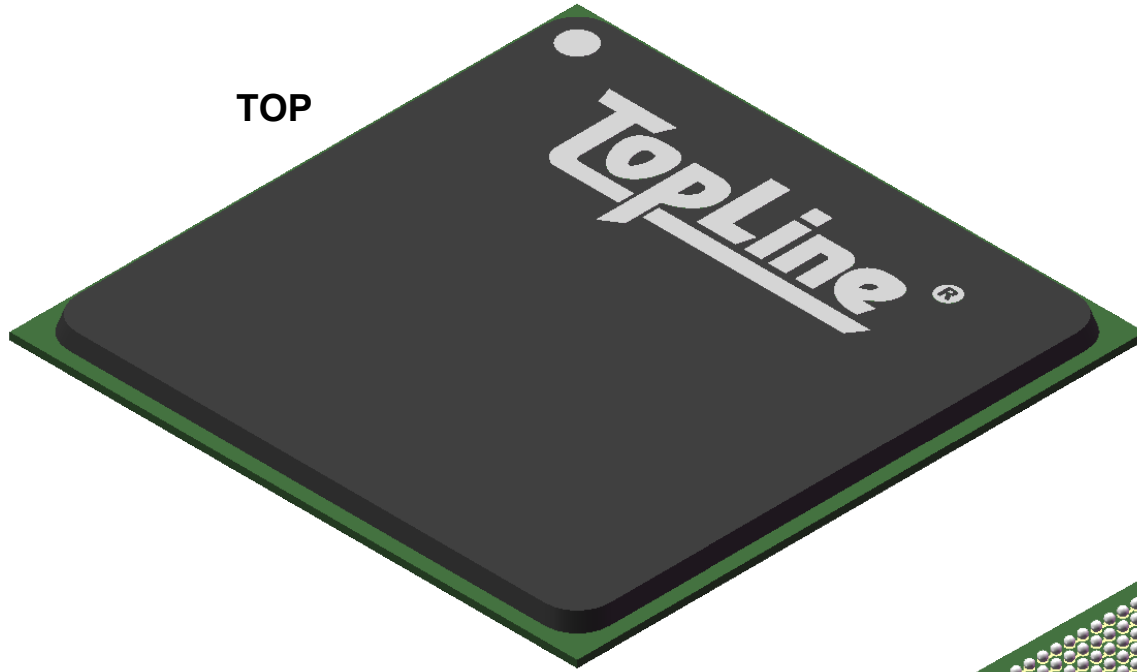

BOTTOM

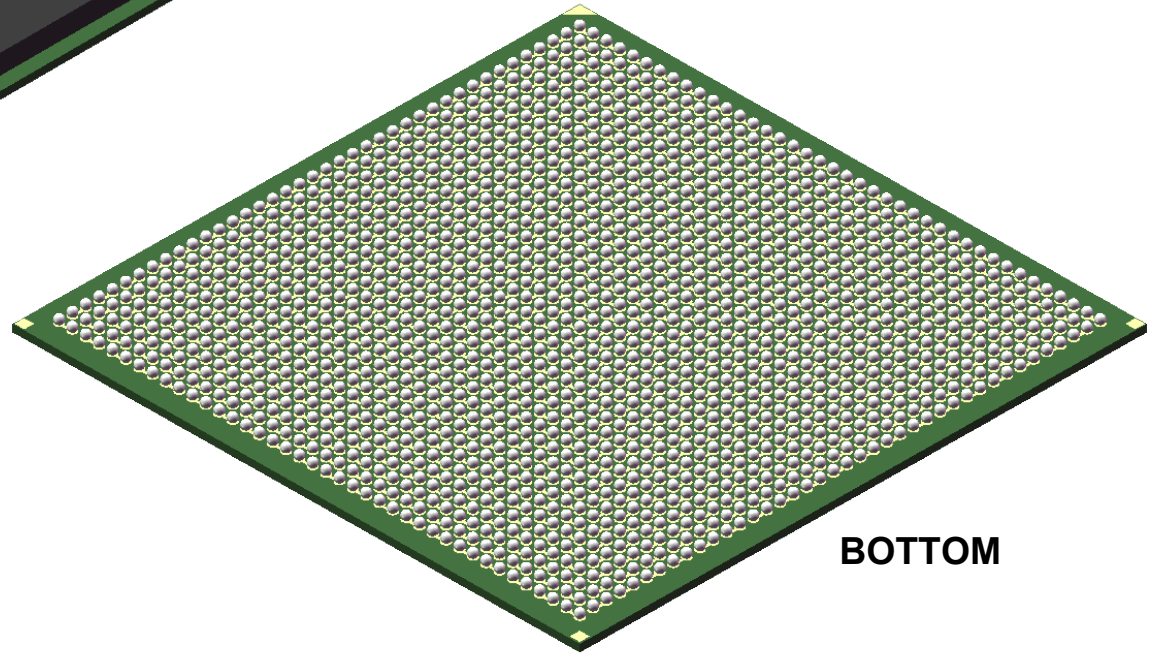

**TopLine**<sup>®</sup>

TITLE (P)BGA1600T1.0-DC409  
DAISY CHAIN DUMMY

SCALE	SIZE	DRAWING NO.	REV
2:1	A	514094	A

DO NOT SCALE DRAWING

SHEET 5 OF 5